

FLOOR SPRING ACCESSORIES

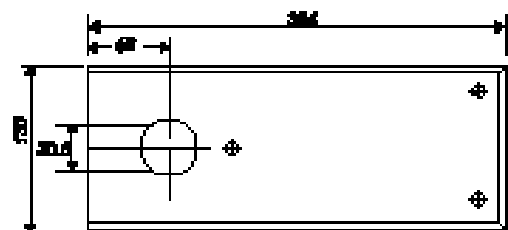

OFS-ACC. CPL. SS
Floor Spring Cover Plate SS'



Adjustable Top C

Accessories
for wooden /
Aluminium Door

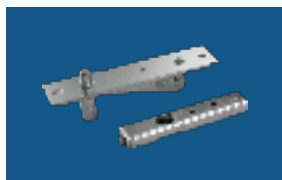

OFS-ACC-TP
Top Pivot Set

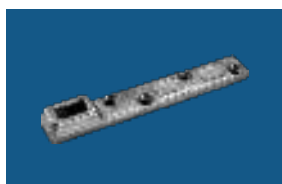

OFS-ACC-BP
Bottom Strap

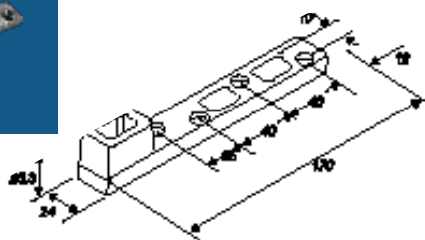
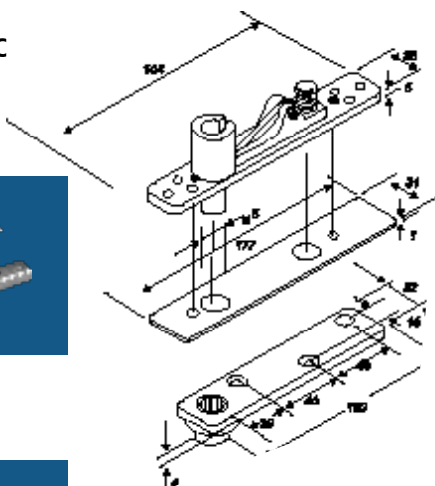

Accessories for Single Action Door

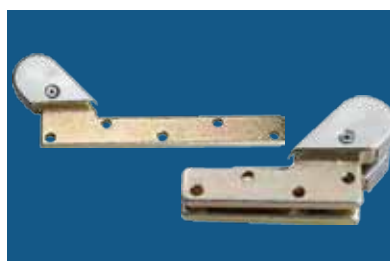

OFS-ACC-OP-L
OFS-ACC-OP-R
Offset Pivot Set

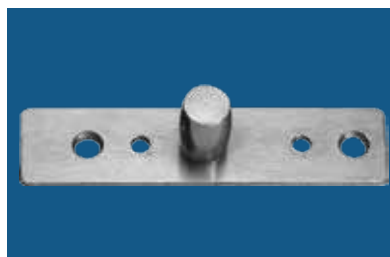
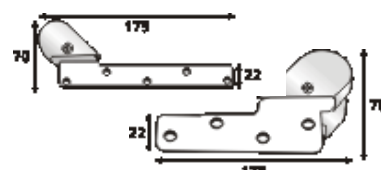

OFS-ACC-GDP
Top Pivot

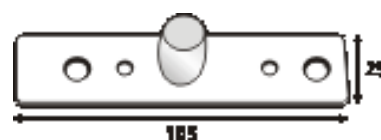

OFS-ACC-MH1
Mini Floor Hinge

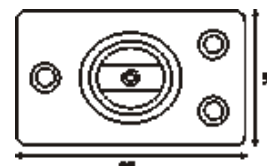

Floor spring type	FS 7400	FS 8400	FS 9400	FS 10400
Closing force	EN 2	EN3	EN 4	EN 4
Maximum door width	850 mm	950 mm	1100 mm	1250 mm
Maximum door weight	55 Kg	80 Kg	150 Kg	270 Kg
Closing speed	130-20 degrees	130-20 degrees	130-20 degrees	130-20 degrees
Final closing speed	20-0 degrees	20-0 degrees	20-0 degrees	20-0 degrees
Hold open (standard)	90° hold open	90° hold open	90° hold open	90° hold open
Hold open (on demand)	No hold open 105° hold open	No hold open 105° hold open	No hold open 105° hold open	No hold open 105° hold open
Weight of floor spring approx	6 Kg	6 Kg	6 Kg	6 Kg
Dimensions including cement box	Length-306 mm Width-108 mm Height-40 mm	Length-306 mm Width-108 mm Height-40 mm	Length-306 mm Width-108 mm Height-40 mm	Length-306 mm Width-108 mm Height-40 mm
Tested to	5,00,000 cycles	5,00,000 cycles	5,00,000 cycles	5,00,000 cycles
Tested as per	EN 1154	EN 1154	EN 1154	EN 1154
Adjustment possible	Height -6 mm	Height -6 mm	Height -6 mm	Height -6 mm
within steel box	Length -8mm Width -8mm	Length -8mm Width -8mm	Length -8mm Width -8mm	Length -8mm Width -8mm